

User instructions

Wall hung RSF gas fired condensing combi boiler

Greenstar i^{ErP}

For central heating systems and indirect fed domestic hot water

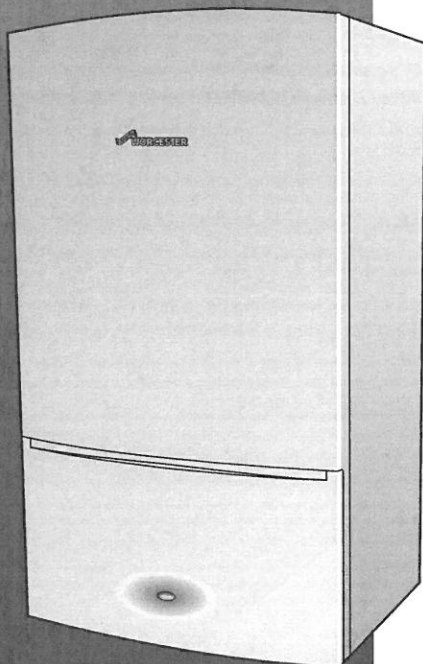

**These appliances are for use with:
Natural Gas or L.P.G.
(Cat. II 2H 3P type C13, C33 & C53)**

	Model	GC Number
Natural Gas	Greenstar 25i ^{ErP}	47-406-60
	Greenstar 30i ^{ErP}	47-406-62
L.P.G.	Greenstar 25i ^{ErP}	47-406-61
	Greenstar 30i ^{ErP}	47-406-63

If you smell gas:

- ▶ Well away from the building: call the National Gas Emergency Service on 0800 111 999.
- ▶ L.P.G. boilers: Call the supplier's number on the side of the gas tank.



Preface

Please read these instructions carefully

These instructions are applicable to the Worcester, Bosch Group appliance model stated on the front cover only.

These instructions apply in the UK/IE only and must be followed except for any statutory obligation.

After installation please leave this User instruction Manual, Installation, Commissioning and Servicing Instructions and completed Benchmark Checklist with the user.

Dedicated to heating comfort

Thank you for purchasing a Greenstar gas-fired condensing combination appliance manufactured by Worcester, Bosch Group. The company prides itself on manufacturing appliances to the strictest quality control standards throughout every stage of production.

Worcester, Bosch group has led the field in innovative appliance design and performance for over 50 years. This heritage means all our products are of exceptional quality and proven reliability.

The Greenstar range in particular is extremely energy efficient, offering you economical running costs and value for money. It is amongst the top energy rated appliances available.

There is also the reassurance of our parts and labour guarantee - backed up by Worcester Total Cover, an optional complete maintenance scheme to keep your appliance operating at peak condition and efficiency.

Contents

1	Key to symbols and safety instructions	4	5	Clearances	22
1.1	Key to symbols	4			
1.2	Safety precautions	4			
2	General information	5	6	Maintaining your appliance	23
2.1	Energy efficiency	5			
2.2	Servicing	5			
2.3	Benchmark standard	5			
2.4	User caution	5			
3	Controls	6	7	Fault finding	24
3.1	Appliance controls	8	7.1	Appliance alert state	25
3.1.1	Appliance display	9	7.2	Appliance reset	25
3.1.2	Basic adjust mode	12	7.3	Extreme cold weather	26
3.2	Central heating	13			
3.2.1	View central heating set temperature	13			
3.2.2	Setting the appliance flow temperature for the central heating system	13			
3.2.3	Set economic temperature - Central heating	14			
3.2.4	Turning the central heating off during the summer	14			
3.2.5	Appliance frost protection	14			
3.3	Domestic hot water	15			
3.3.1	View domestic hot water set temperature	15			
3.3.2	Setting the flow temperature for the domestic hot water	15			
3.3.3	Mid point domestic hot water temperature	16			
3.3.4	Domestic hot water eco and preheat modes	16			
3.3.5	Domestic hot water preheat mode manual activation (Eco mode off)	17			
3.3.6	Domestic hot water preheat mode timed activation, with fascia timer or external timer connected (eco mode off)	17			
3.3.7	Turn off the heat requirement demand light (blue)	17			
4	System pressure	18	8	Fault or breakdown	26
4.1	Sealed heating system	18			
4.2	Locating the integral filling link	18			
4.3	Optional integral keyless filling link	19			
4.4	Optional integral keyed filling link	20			
4.5	External filling link	21			
			9	Tips on energy saving	27
			10	Environment/disposal	28
			11	Your guarantee	28
			12	Glossary	29

1 Key to symbols and safety instructions

1.1 Key to symbols

Warnings

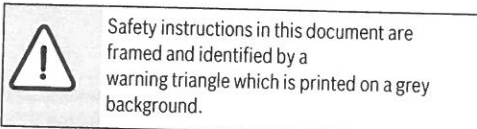

The following keywords are defined and can be used in this document:

- **NOTICE** indicates a situation that could result in damage to property or equipment.
- **CAUTION** indicates a situation that could result in minor to medium injury.
- **WARNING** indicates a situation that could result in severe injury or death.
- **DANGER** indicates a situation that will result in severe injury or death.

Important information



This symbol indicates important information where there is no risk to people or property.

Additional symbols

Symbol	Meaning
1.	a numbered step in an action sequence
▶	a step in an action sequence
→	a reference to a related part in the document or to other related documents
①	a reference number to identify or refer to a part or item
•	a list entry
-	a list entry (second level)

Table 1

Examples of additional symbols used

A numbered step in an action sequence

A sequence of numbered steps or actions carried out in a specific order to complete a task.

1. First action
2. Second action
3. Third action
- etc.

A step in an action sequence

A sequence of defined actions or steps carried out in order to complete a task.

- ▶ Action
- ▶ Next action
- ▶ etc

A reference to a related part in the document or to other related documents.

To refer the reader to a specific figure/table/section within the manual.

→ e.g. figure 1.

A reference number to identify or refer to a part or item.

In a related figure, items or parts identified by a sequential number.

List entries, first and second levels

- A single component/item
- A component/list, made up of multiple parts/items.
 - Sub component or sublist of main component/list.
 - etc.

1.2 Safety precautions

If you smell gas:

A gas leak could potentially cause an explosion. If you smell gas, observe the following rules.

- ▶ Prevent flames or sparks:
 - Do not smoke, use a lighter or strike matches.
 - Do not operate any electrical switches or unplug any equipment.
 - Do not use the telephone or ring doorbells.
- ▶ Turn off the gas at the meter or regulator.
- ▶ Open windows and doors.
- ▶ Warn your neighbours and leave the building.
- ▶ Prevent anyone from entering the building.
- ▶ Well away from the building: call the National Gas Emergency Service on 0800 111 999.
- ▶ L.P.G. boilers: Call the supplier's number on the side of the gas tank.

Appliance operation:

This appliance can be used by children aged from 8 years and above and persons with reduced physical, sensory or mental capabilities or lack of experience and knowledge, if they have been given supervision or instruction concerning the use of the appliance, in a safe way, and understand the hazards involved.

Children shall not play with the appliance.

Cleaning and user maintenance shall not be made by children without supervision.

Combustible and corrosive materials:

Chemically aggressive substances can corrode the appliance and invalidate any guarantee.

- Do not store or use any combustible materials (paper, thinners, paints, propellants, cleaning agents etc.) inside the cupboard containing the appliance or within the vicinity of the appliance.

Fittings and modifications:

Only a competent engineer can remove the appliance case and carry out any work, in accordance with the Gas Safety (Installation and Use) Regulations.

- Do not remove the appliance case.

Any misuse or unauthorised modifications to the appliance, flue or associated accessories and heating system will invalidate the guarantee.

- Do not modify the appliance or flue system in any way.

Worcester, Bosch Group accepts no liability arising from any such actions. This does not affect your statutory rights.

Cleaning the appliance case:

Use a damp, soft cloth to clean the outer painted metal case of the appliance, do not use chemicals or abrasive materials.

2 General information

2.1 Energy efficiency

Energy efficiency information is given in the Installation, Commissioning and Servicing Instructions supplied with the appliance.

2.2 Servicing



Ensure that the service engineer completes the Service Record in the Benchmark Checklist after each service. The Benchmark Checklist and service interval record can be found at the rear of the Installation, Commissioning and Servicing Instructions.

- The appliance must be serviced regularly by a competent, qualified person, such as a Worcester service engineer or other Gas Safe registered engineer.
- Always use original spares, to help maintain the efficiency, safety and reliability of the appliance and have the Service Record completed in the Benchmark Checklist.

The completed Benchmark Checklist will be required in the event of any guarantee work and may be required by the local Building Control Inspector.

2.3 Benchmark standard



The Benchmark initiative is a code of practice to encourage the correct installation, commissioning and servicing of domestic central heating appliances and system equipment.

A "checklist" is dispatched with every appliance and can be found towards the back of the Installation, Commissioning and Servicing Instructions. This is a vital document that needs to be completed by the installer at the time of installation. It confirms that the appliance has been installed and commissioned according to the manufacturer's instructions.

The service record provides space for the recording of regular servicing of the appliance/heating system and this can become a valuable document when, for example, you wish to sell the property. The service record will show a potential purchaser that the heating system has received regular professional maintenance and servicing during its lifetime.

The Benchmark initiative aims to:

- Raise standards among professional installers
- Build and maintain high safety standards in the industry
- Improve customer satisfaction levels
- Make a contribution to the nation's commitment to climate change

2.4 User caution

- It is forbidden for any interference with the appliance other than those actions allowed in this document.



CAUTION: Incorrect use

- ▶ Any incorrect use can result in danger to the householder.

3 Controls

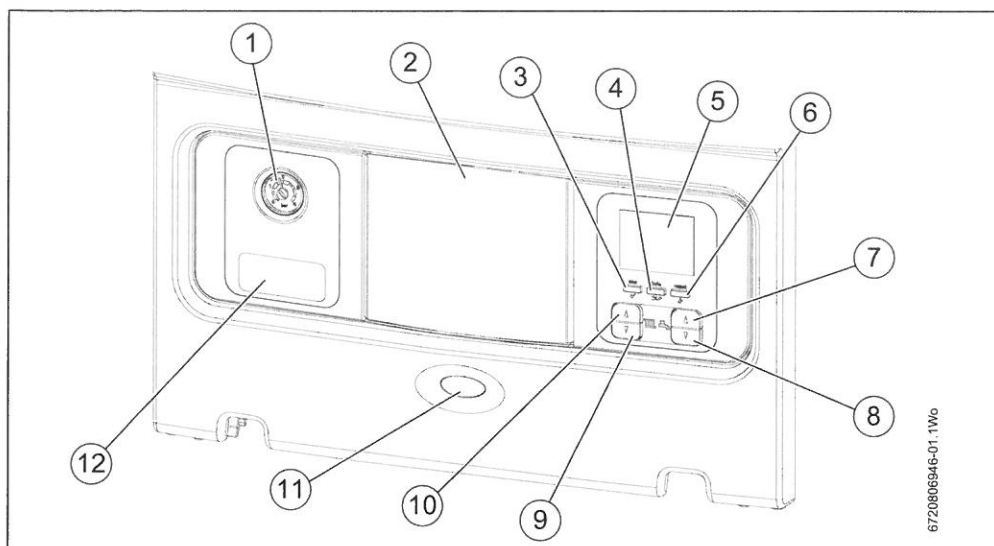

Fig. 1 Appliance control panel

Item	Description
1	System pressure gauge <ul style="list-style-type: none"> • Displays pressure in the heating system and appliance
2	Position for optional programmer <ul style="list-style-type: none"> • Worcester plug in controls position
3	ECO/OK button <ul style="list-style-type: none"> • Dual function button <ul style="list-style-type: none"> - ECO (toggles domestic hot water preheat ON/OFF) - OK (menu confirmation)
4	Info/Return/Spinner button <ul style="list-style-type: none"> • Multi function button <ul style="list-style-type: none"> - Info (Information menu access) - Return (return to previous screen) - Spinner (engineer function)
5	Appliance display <ul style="list-style-type: none"> • Temperature and information display
6	Reset/Service engineer button <ul style="list-style-type: none"> • Dual function button <ul style="list-style-type: none"> - Reset (appliance reset) - Service engineer (engineer service and set up function)

Table 2 Legend to figure 6

Item	Description
7	Domestic hot water settings increase temperature/menu scroll up button <ul style="list-style-type: none"> • Dual function button <ul style="list-style-type: none"> – Increase temperature (increase the desired hot water temperature) – Menu scroll up (scroll upwards through menu items)
8	Domestic hot water settings decrease temperature/menu scroll down button <ul style="list-style-type: none"> • Dual function button <ul style="list-style-type: none"> – Decrease temperature (decrease the desired hot water temperature) – Menu scroll down (scroll downwards through menu items)
9	Central heating settings decrease button <ul style="list-style-type: none"> • Decrease temperature (decrease the desired flow temperature)
10	Central heating settings Increase button/Increase button <ul style="list-style-type: none"> • Increase temperature (increase the desired flow temperature)
11	Heat requirement demand and fault indicator (blue) <ul style="list-style-type: none"> • Dual function <ul style="list-style-type: none"> – Heat requirement demand (illuminates during a central heating or hot water requirement demand) – Fault indicator (flashes during a fault condition)
12	Appliance identification label <ul style="list-style-type: none"> • Details on appliance model, serial number and gas council number

Table 2 Legend to figure 6

3.1 Appliance controls

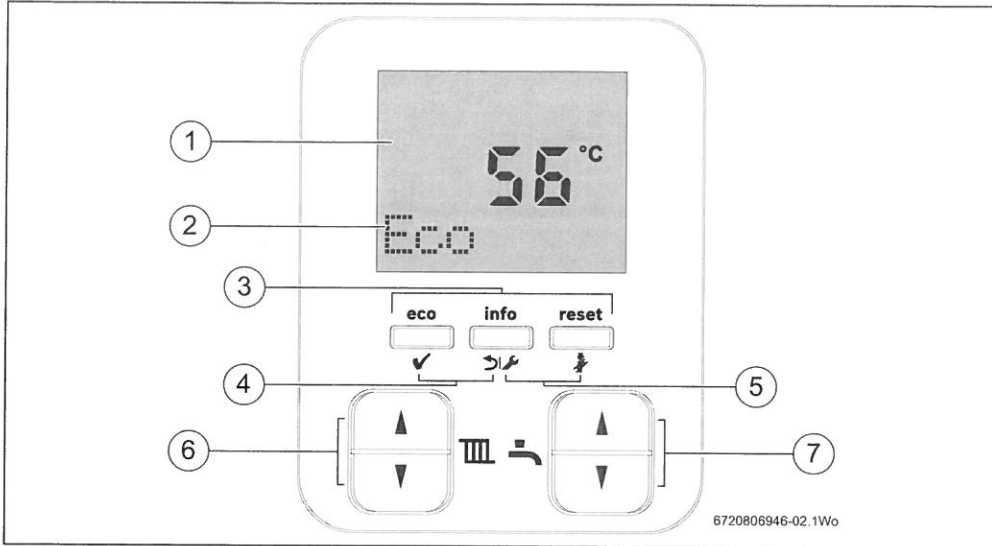













Fig. 2 Display (example in standby with Eco mode active) and buttons

- [1] Display Screen
- [2] Eco mode active display message
- [3] User function buttons:
- Eco button ()
 - Manually select Economy or Pre-Heat mode
 - Info button ()
 - Access to Info menu Function
 - Reset button ()
 - Appliance reset button
- [4] Menu functions buttons:
- OK button ()
 - Confirms a selection
 - Back button ()
 - To return to the previous option or menu
- [5] Engineer function buttons:
- Spanner button ()
 - Service menu function button only
 - Chimney sweep button ()
 - Engineer service and set up function only
- [6] Central heating flow temperature adjustment buttons:
- Increase button ()
 - Increase value
 - Decrease button ()
 - Decrease value
- [7] Hot water maximum temperature adjustment buttons (also used in menu /scroll/adjustment, indicated by arrows on right of text display line):
- Increase button ()
 - Increase value
 - Decrease button ()
 - Decrease value

3.1.1 Appliance display







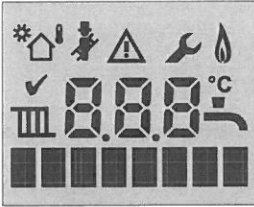

SCREEN DISPLAY	DESCRIPTION
All possible screen symbols 	This screen is displayed briefly during appliance start up and shows all the symbols that could be displayed.
Alpha/Numerical display 	Displays a temperature or appliance status code.
Text display 	Displays status, diagnostic code and short description information.
Right hand arrows (text display) 	Use domestic hot water arrow buttons to alter the menu item.
Flashing T (text display) 	Appliance in component test mode.
Flashing A (text display) 	Appliance in air purge mode.
Hot water 	Displays this symbol during domestic hot water use.
Central Heating 	Displays this symbol during a central heating use.
Chimney sweep mode 	Displays during service when the appliance is set to maximum or minimum output.

Table 3 Symbol description

Controls





Alert 	Displays with the appliance status code and diagnostic code during a fault condition.
Service mode 	Displays when a qualified service engineer is in the service menus.
Burner on 	The appliance is in operation and the flame is alight.
Centigrade °C	Displays next to the temperature reading.
Confirmation 	This symbol confirms a setting change.

Table 3 Symbol description

Info menu and operational status codes

These are not faults, but provide information concerning the current status of the appliance.

During normal appliance operation various Status codes can be displayed by pressing the  button.

The first screen of the Information menu displays the current Status code, this will change as the appliance runs through the various modes and sequences.

Info menu No.	Description
i1	Current status <ul style="list-style-type: none"> Appliance current operating status (see table 5 for operational status codes).
i2	Previous status <ul style="list-style-type: none"> Appliance previous operating status (see table 5 for operational status codes).
i3	Maximum central heating output <ul style="list-style-type: none"> Maximum central heating output (kW) set on the appliance.
i4	Maximum domestic hot water output (kW) <ul style="list-style-type: none"> Maximum domestic hot water output (kW) set on the appliance.
i6	Domestic hot water flow detected <ul style="list-style-type: none"> A minimum flow rate of approximately 2.9 l/m has been detected by the appliance. <ul style="list-style-type: none"> YES = Flow detected No = No flow detected
i8	Ionization current <ul style="list-style-type: none"> Measured ionisation current (μA).
i9	Flow temperature <ul style="list-style-type: none"> Measured primary flow temperature of the appliance ($^{\circ}$C).
i11	Domestic hot water outlet temperature <ul style="list-style-type: none"> Measured DHW flow temperature of the appliance ($^{\circ}$C).
i12	Domestic hot water set temperature <ul style="list-style-type: none"> Displays the current set temperature for the domestic hot water.
i15	Outdoor sensor <ul style="list-style-type: none"> Temperature reading from outdoor temperature sensor, (only available if an outdoor sensor accessory is fitted)
i20	CU version <ul style="list-style-type: none"> Software version of the control box
i21	HMI version <ul style="list-style-type: none"> Software version of the HIS (Human Interface Software).
i22	HCM version <ul style="list-style-type: none"> Identification number of the HCM (Heating Control Module) and release version.

Table 4 Info menu

These are not faults, but provide information concerning the current status of the appliance.

During normal appliance operation various Status codes can be displayed by pressing the  button.

The first screen of the Information menu displays the current Status code, this will change as the appliance runs through the various modes and sequences.

Status code	Description
200	Central heating system is being heated.
201	Domestic hot water system is being heated.
202	Anti rapid cycle mode. <ul style="list-style-type: none"> The boiler has commenced anti-cycle period for CH. Can be adjusted in boiler settings (2.3b). Default 5 Minutes
203	System stand by <ul style="list-style-type: none"> The appliance is waiting for the heating system to cool.
204	System waiting.
208	Appliance in service Test mode (Min/Max)
265	EMS intelligent controller has forced stan-by-mode due to low heating load. <ul style="list-style-type: none"> The appliance is compensating for the power required from the EMS room controller is less than the minimum output of the boiler).
268	Component test mode. <ul style="list-style-type: none"> Appliance is running the manual component test as activated in the menus.
270	Power up mode. <ul style="list-style-type: none"> (appliance is powering up).
283	Burner starting. <ul style="list-style-type: none"> The boiler prepares for a burner start. The fan and the pump are being controlled.
284	Gas valve(s) opened, flame must be detected within safety time. <ul style="list-style-type: none"> The boiler prepares for a burner start. The gas valve is being controlled.
305	Anti fast cycle mode (domestic hot water keep warm function). <ul style="list-style-type: none"> Diverter valve is held in hot water position for a period of time (determined by the software) after hot water demand
309	Central heating and domestic hot water system are being heated.
357	Appliance in air purge mode. <ul style="list-style-type: none"> Primary heat exchanger air venting program active - approximately 100 seconds.
358	Three way valve kick. <ul style="list-style-type: none"> If the 3-way valve hasn't moved in within 48 hours, the valve will operate once to prevent seizure.

Table 5 Operational status codes

3.1.2 Basic adjust mode



If you see basic adjust mode in the home screen when attempting to make temperature adjustments, the appliance has been optimised for your heating system and should not need adjustment. Please use your room thermostat to adjust your heating temperature if you still cannot achieve the desired room temperature the Installation, Commissioning and Servicing Instructions contain details on how to disable the basic adjust mode; this will allow further adjustment of the appliances settings.

3.2 Central heating

3.2.1 View central heating set temperature

The home screen will show the current appliance temperature [1].

- ▶ Briefly press either central heating adjustment buttons.
The display will change to the set temperature for the central heating [2].
- ▶ Press the OK button to confirm that the set temperature has been viewed, the display will also return to home screen [3].

-or-

- ▶ Wait 4 seconds and the display will return to the home screen [3].

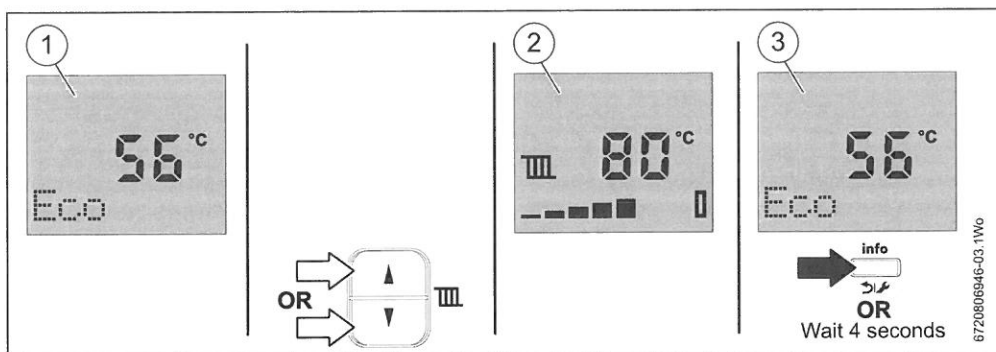

Fig. 3 Viewing central heating set temperature

3.2.2 Setting the appliance flow temperature for the central heating system

The home screen will show the current appliance temperature [1].

- ▶ Press the central heating increase or decrease adjustment buttons to select the desired flow temperature.
The temperature displayed increases [2] /decreases [3] according to the adjustment made.
By holding the increase/decrease button the temperature displayed begins to change by larger increments.
- ▶ Press the OK button to confirm the value selected, the display will also return to the home screen [4].

-or-

- ▶ Wait 4 seconds for auto confirm and the display will return to the home screen [4].

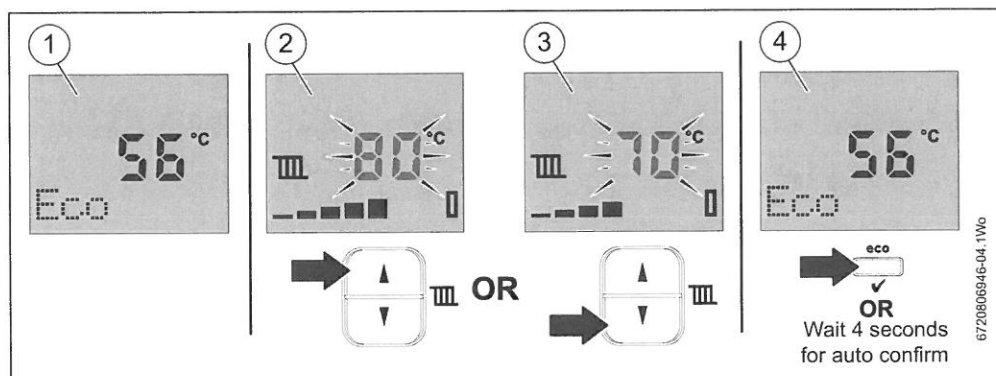

Fig. 4 Adjust central heating flow temperature

3.2.3 Set economic temperature - Central heating

This setting ensures that the appliance will operate efficiently and is suitable for most heating system.

The home screen will show the current appliance temperature.

- ▶ Press the central heating increase or decrease adjustment buttons to enter temperature adjustment mode.
 - ▶ Press both the central heating adjustment buttons.
The display will change to the economic value for the central heating. This will be indicated by a hollow block approximately mid way in the temperature scale at the bottom of the display [1].
 - ▶ Press the OK button to confirm value selection, the display will also return to the home screen [2].
- or-
- ▶ Wait 4 seconds for auto confirm and the display will return to the home screen [2].

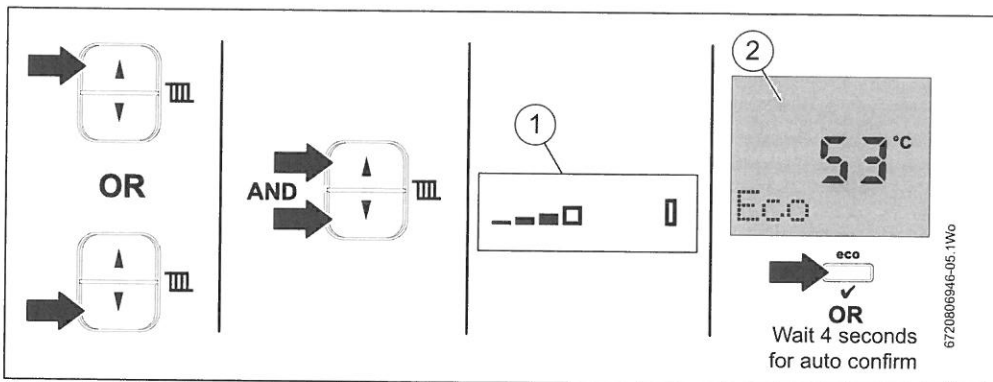

Fig. 5 Central heating economic temperature

3.2.4 Turning the central heating off during the summer



Do not switch the appliance off at the mains fused spur.

- ▶ To turn your central heating off during warm periods:
 - ▶ Set the programmer to OFF
- or-
- ▶ Turn the room thermostat temperature down to minimum.

3.2.5 Appliance frost protection

If you are leaving your property unoccupied during cold weather, please leave your programmer on constant and your room thermostat set to 15°C.

- ▶ If the temperature within the appliance falls below 8°C the pump will run to circulate water and prevent the system freezing.
 - If the temperature does not rise to 9°C within 30 minutes of the pump operating, the appliance will fire up.
- ▶ If the temperature within the appliance falls below 5°C the appliance will fire immediately, bringing the appliance temperature up to 12°C to avoid the possibility of the appliance freezing.
- ▶ This process will be repeated until such time that the appliance temperature does not drop below 8°C.

3.3 Domestic hot water

3.3.1 View domestic hot water set temperature

The home screen will show the current appliance temperature [1].

- ▶ Briefly press either hot water adjustment buttons.
- ▶ The display will change to the set temperature for the hot water [2].
- ▶ Press the OK button to confirm the value selected, the display will also return to home screen [3].

-or-

- ▶ Wait 4 seconds and the display will return home screen [3].

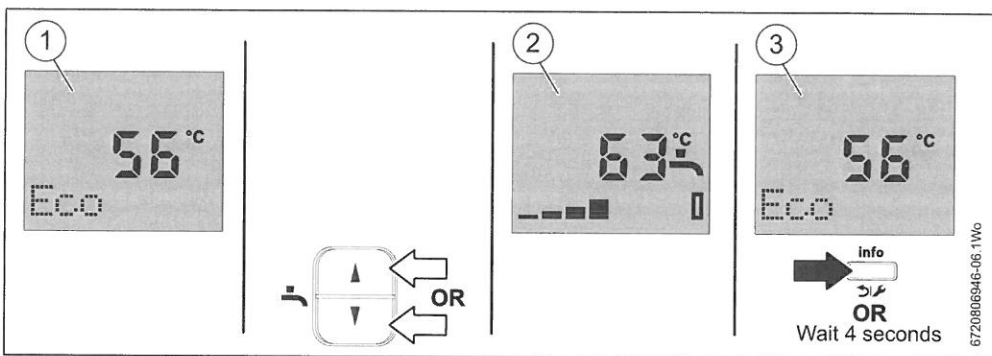

Fig. 6 Viewing hot water set temperature

3.3.2 Setting the flow temperature for the domestic hot water

The home screen will show the current appliance temperature [1].

- ▶ Press the hot water increase or decrease adjustment buttons to select the desired flow temperature. The temperature displayed increases [2] /decreases [3] according to adjustment made. By holding the increase/decrease button the temperature displayed begins to change by larger increments.
- ▶ Press the OK button to confirm the value selected, the display will also return to home screen [4].

-or-

- ▶ Wait 4 seconds for auto confirm and the display will return to the home screen [4].

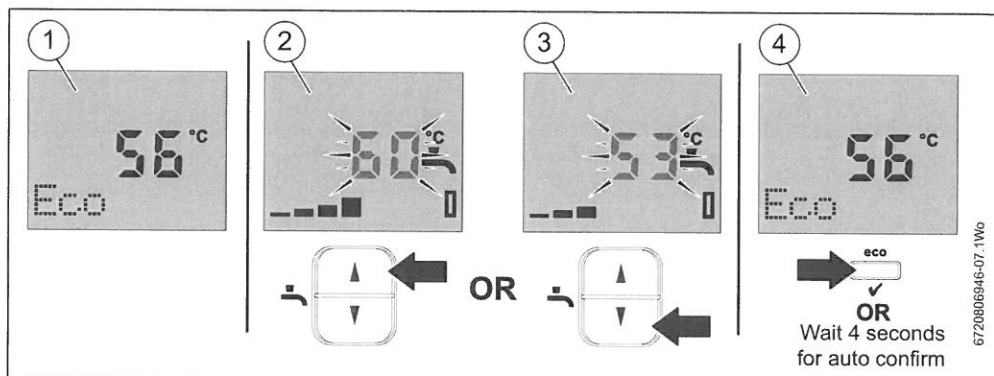

Fig. 7 Adjust hot water flow temperature

3.3.3 Mid point domestic hot water temperature

The mid point sets the maximum temperature for the hot water.

The home screen will show the current appliance temperature.

- ▶ Press the hot water increase or decrease adjustment buttons to enter temperature adjustment mode.

- ▶ Press both the hot water adjustment buttons.

The display will change to the economic value for the hot water. This will be indicated by a hollow block approximately mid way in the temperature scale at the bottom of the display [1].

- ▶ Press the OK button to confirm the value selected, the display will also return to the home screen [3].

-or-

- ▶ Wait 4 seconds for auto confirm and the display will return to the home screen [3].

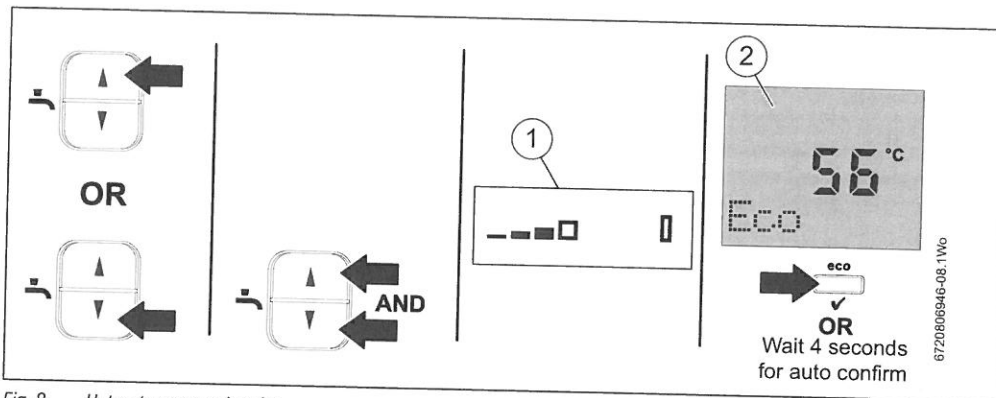

Fig. 8 Hot water economic value

3.3.4 Domestic hot water eco and preheat modes

- Preheat mode, the hot water heat exchanger is kept pre-heated to reduce the time taken to deliver hot water at the tap.
- Eco mode is an energy saving feature which disables the Preheat function. Eco is enabled by default, during the initial appliance start up and Eco is displayed.

In the Preheat mode, if there has been no demand for hot water for 24 hours the appliance will save energy by suspending Preheat until there is a demand for hot water. At this time Preheat mode is re-activated. It is advised to use a twin channel programmer to time the Preheat function and switch it off when it is not needed.

3.3.5 Domestic hot water preheat mode manual activation (Eco mode off)

Eco mode active [1]:

- ▶ Press the eco button (approximately 1 second) to enter the Preheat mode, when Preheat mode is active, "Preheat" will be displayed [2].
- ▶ To exit Preheat mode and return to Eco, press the eco button (approximately 1 second), Eco will be displayed [3].

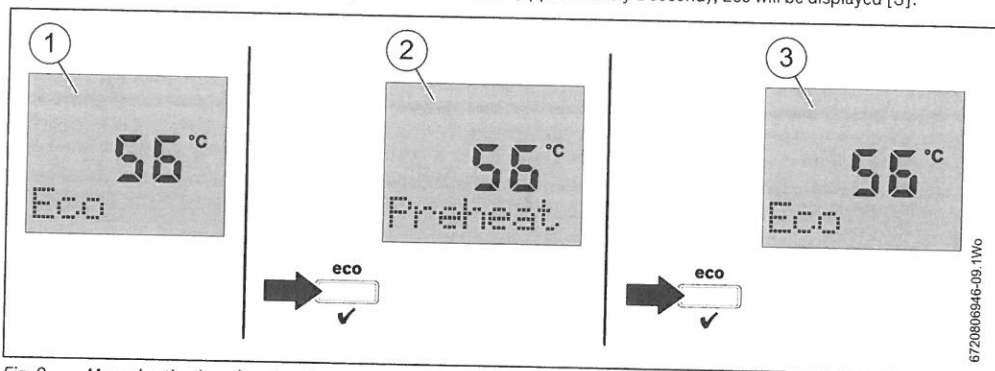

Fig. 9 Manual activation of preheat/eco mode

3.3.6 Domestic hot water preheat mode timed activation, with facia timer or external timer connected (eco mode off)

When a twin channel programmer is fitted/connected, the Preheat/Eco option can be selected via the programmer.

- Programmer hot water channel ON periods:
 - Preheat mode is active and indicated on the appliance display [2].
- Programmer hot water channel OFF periods:
 - Eco mode active and indicated on the appliance display [1] & [3].

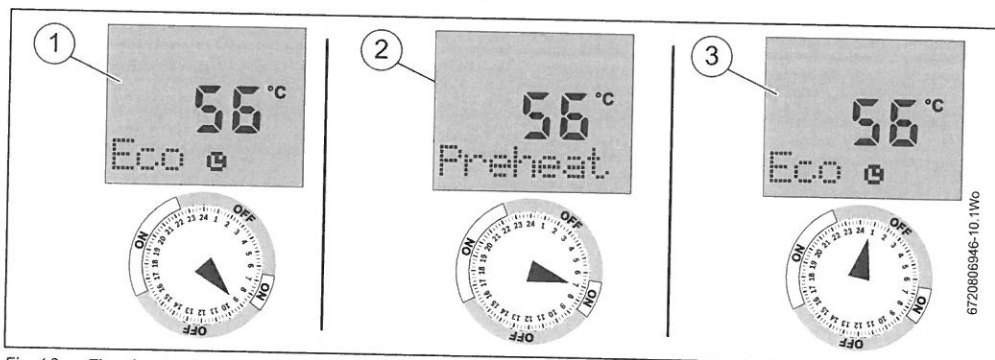

Fig. 10 Timed activation of Preheat/Eco mode

3.3.7 Turn off the heat requirement demand light (blue)

You may choose to deactivate the heat requirement demand light. Please ask your installer to set-up this feature.

The light will still flash to alert you to a possible fault, but will not activate during a heat requirement demand for heating or hot water.

4 System pressure

4.1 Sealed heating system

This appliance is fitted to a sealed heating system which is pre-pressurised. Your installer will advise you of the minimum and maximum pressure indicated on the pressure gauge.

- ▶ Check regularly that the pressure is maintained.
- ▶ If the pressure gauge reads less than 1 bar then the system requires re-charging.
- ▶ Contact your installer or maintenance engineer if a permanent significant decrease or increase in pressure is indicated on the pressure gauge.

The filling method will be one of three types:

- Optional "Keyless" integral filling
- Optional "keyed" filling link
- An external filling loop, fitted valves and flexible hose.

4.2 Locating the integral filling link

- ▶ Remove bottom panel by pulling the catch down and then pulling the panel forward and down to remove.
The integral filling link (if fitted) will be located to the right hand side of the appliance.

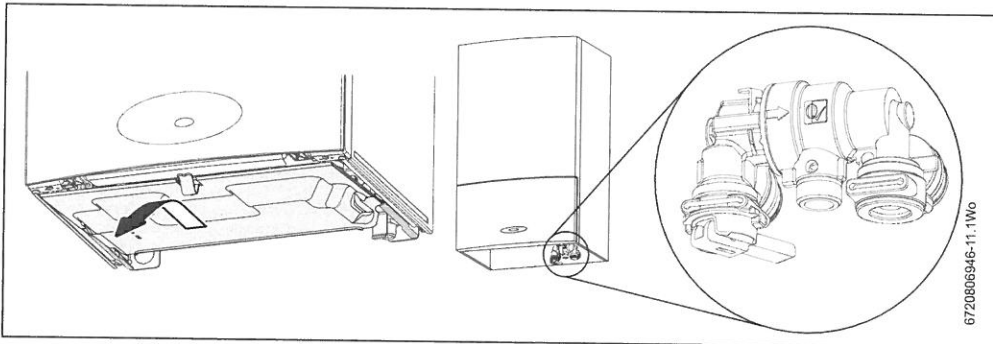

Fig. 11 Locating the integral filling link

4.3 Optional integral keyless filling link

Locate the filling link and follow the instructions for re-pressurising.

1. If the needle [1] on the appliance pressure gauge reads less than 1 bar, re-charge the system.
2. Pull the blue lever down to start the filling process.
3. Monitor the pressure gauge on the appliance facia.

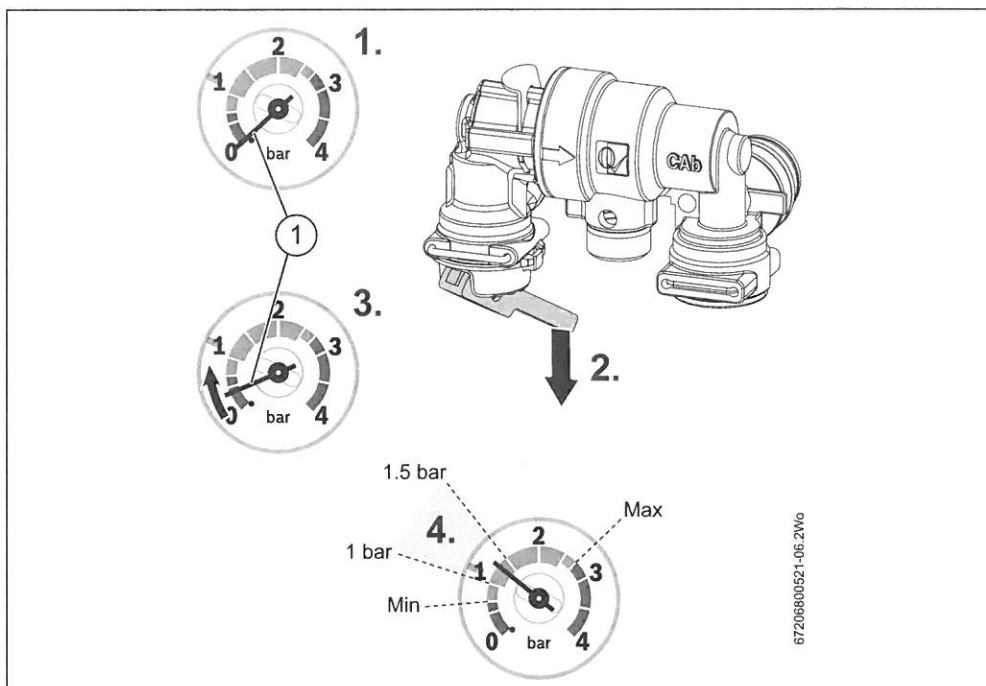

Fig. 12 Keyless filling link

4. When the needle reaches between 1 to 1.5 bar on the gauge, release the blue lever to stop the filling process.

4.4 Optional integral keyed filling link

Locate the filling key and follow the instructions for re-pressurising.

1. Push the filling key firmly into the body of the filling link, ensuring the arrow on the key shaft lines up with the open padlock symbol.
2. Turn the filling key to the right, to the stop, ensure the key is locked and that it cannot still turn. The arrow should line up with the closed padlock symbol. This bridges the gap between the two sections of the filling loop.
3. Turn the white knob to the left, this will allow water to fill the system.
4. When the pressure, shown on the appliance facia pressure gauge, reaches between the 1 and 1.5 bar marks (zone A), turn the white knob to the right to close the valve. Do not overtighten.
5. Turn the filling key to the left, to the stop, so that the arrow lines up with the open padlock symbol and pull the key straight down to remove. Please remember to store the key in the bottom panel.

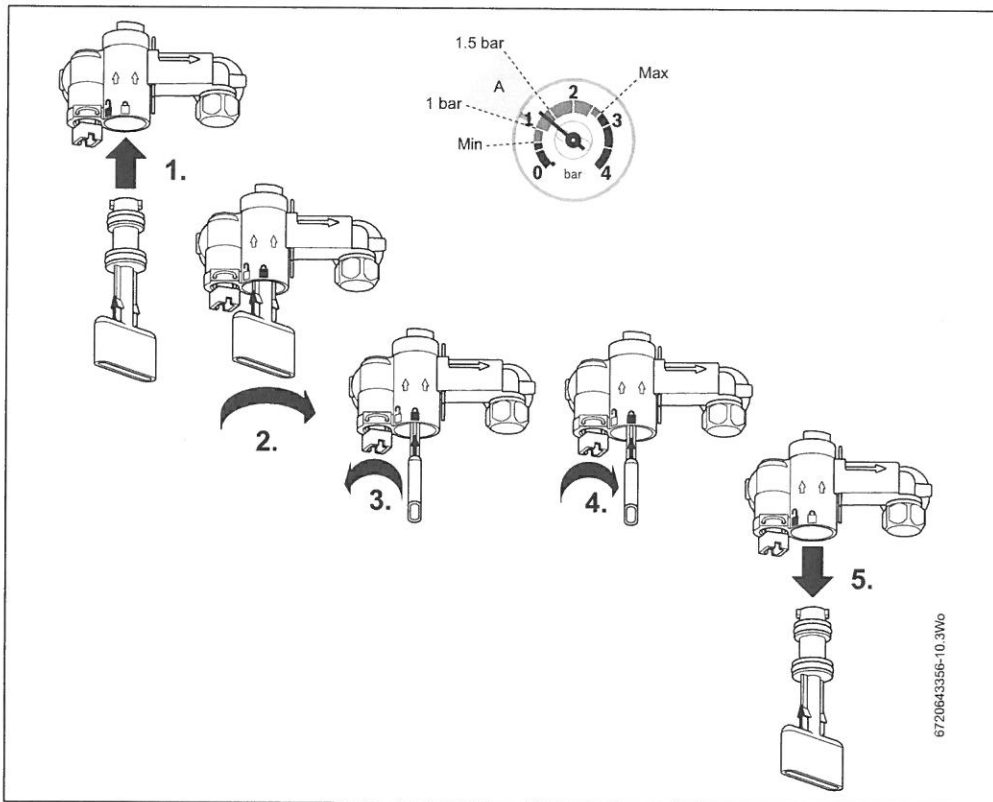

Fig. 13 Keyed filling link



If the pressure gauge reads more than 1.5 bar as a result of over filling, bleed one radiator until the pressure gauge returns to between 1 and 1.5 bar.

4.5 External filling link

Once the external filling loop has been located, follow the instructions for re-pressurising the system.

1. Unscrew blanking cap.
2. Attach the hose to the valves, screw on hand-tight.
3. Turn the handle/screwdriver slot through 90° to open the valves.
4. The handle/screwdriver slot will be in-line with the valves

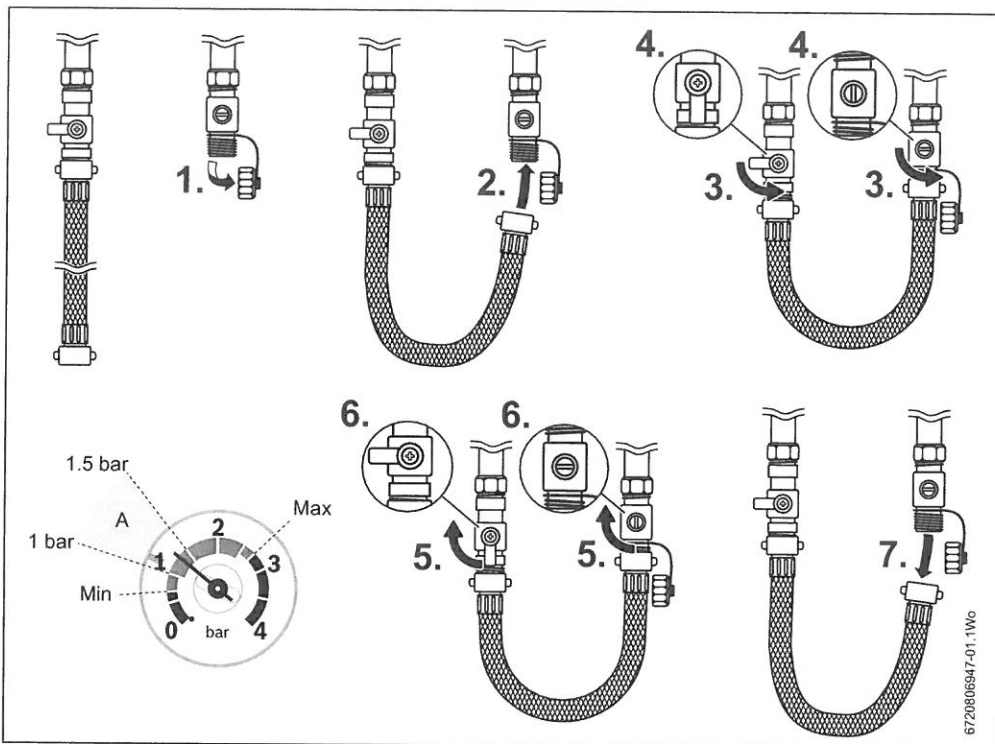

Fig. 14 External filling loop

5. When the pressure reaches between the 1 and 1.5 bar marks (zone A), turn the handle/screwdriver slot back, through 90°, to close the valve.
6. The handle/screwdriver slot will be at 90° to the valves
7. Remove the hose and replace the blanking caps.

5 Clearances

Your installer will have provided adequate space around the appliance for safety and servicing access.



CAUTION: Restricted space.
The appliance may overheat.

- ▶ Do not restrict this space with the addition of cupboards, shelves etc. next to the appliance.



NOTICE: Combustible and corrosive materials:

Chemically aggressive substances can corrode the appliance and invalidate any guarantee.

- ▶ Do not store or use any combustible materials (paper, thinners, paints, propellants, cleaning agents etc.) inside the cupboard containing the appliance or within the vicinity of the appliance.

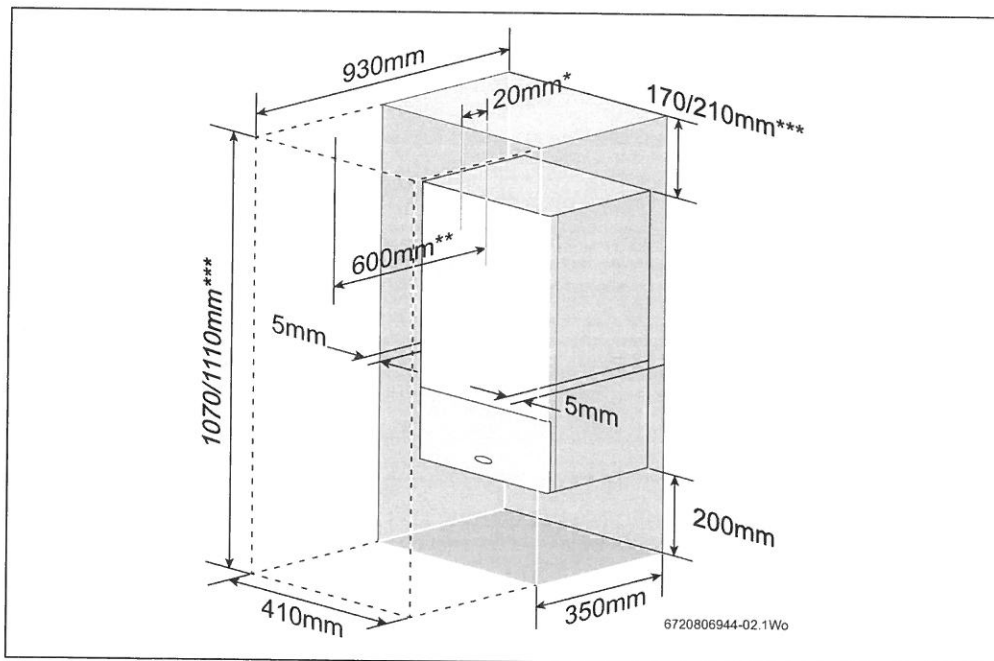

Fig. 15 Unventilated compartment

[*] Minimum clearances to removable door

[**] Minimum clearances required for servicing

[***] Height for either 60/100 flue or 80/125 flue

6 Maintaining your appliance

Your new gas-fired appliance represents a long term investment in a reliable, high quality product.

Wipe the appliance casing with a soft clean cloth. Please do not use chemical cleaning products which may damage the paint finish.

In order to realise its maximum working life, and to ensure it continues to operate at peak efficiency and performance, it is essential that your appliance receives regular servicing and maintenance checks from a competent person beyond the initial guarantee period.

If your Greenstar gas-fired appliance should fail to operate correctly or requires servicing, please contact the Worcester, Bosch Group Appointments Team (see rear cover for details).

Details of the appliance including the Gas Council number can be found on the front cover of these User Instructions and on the appliance identification label on the appliance fascia.

The Gas Council number is also listed on the front cover of your Installation, Commissioning and Servicing Instructions.

7 Fault finding

In the event that the appliance stops functioning or does not perform as expected, please see table below. These problems are some of the most common causes. Should the problem persist or if other fault codes are displayed, then it will be necessary to contact Worcester, Bosch Group.

This table gives information on basic operating system problems.

Problem	Cause	Remedy
EA fault code flashing on display	No gas supply/low gas supply pressure	▶ Contact your gas supplier.
	Condensate outlet blocked	▶ If it is safe to do so, check your condensate pipe outlet for blockages, such as ice or foreign objects.
	Flue blocked	▶ If it is safe to do so, check your flue outlet for damage or blockages.
Desired room temperature is not reached	Thermostatic radiator valve(s) set too low	▶ Increase thermostatic radiator valve setting(s).
	Temperature control for central heating flow on appliance set too low	▶ Increase central heating flow temperature control setting.
	Low temperature setting on the room thermostat	▶ Increase setting on the room thermostat.
	Air trapped in heating system	▶ Bleed radiators and re-pressurise the heating system.
	Low system water pressure	▶ Re-pressurise the system, refer to page 19.
Desired room temperature too high	Thermostatic radiator valves are set to high	▶ Turn down thermostatic radiator valves.
	Room thermostat is set too high	▶ Turn down room thermostat.
Radiators are too hot	Temperature control on appliance set too high	▶ Reduce central heating temperature by turning down the Central Heating control on appliance. Note: This could prevent your property reaching the desired temperature during cold weather periods.
Heating stays on for too long	Clock is incorrectly set	▶ Check clock setting and adjust.
No blue Operation/Fault Indicator demand	Momentary power failure	▶ Disconnect appliance supply, wait a few seconds then reconnect.
	Heat requirement demand operation light has been deactivated	▶ Ask your installer to reactivate the blue light
Hot water temperature too low	Temperature set too low on appliance controls	▶ Check setting and adjust.
	Water flow at tap too high	▶ Reduce flow rate at tap.
	Air trapped in heating system	▶ Bleed radiators and re-pressurise the heating system.
	Low system water pressure	▶ Re-pressurise the system, refer to page 19.
Hot water temperature too high	Temperature set too high on appliance controls	▶ Check setting and adjust.
	Water flow at tap too low	▶ Increase flow rate at tap.

Table 6 Fault finding

7.1 Appliance alert state

In the event of an alert, a fault code and an alert symbol  will be displayed, and the blue operation/fault light will flash.

The information about the alert state will flash and scroll along the text display segment of the screen, giving more details of the alert state.

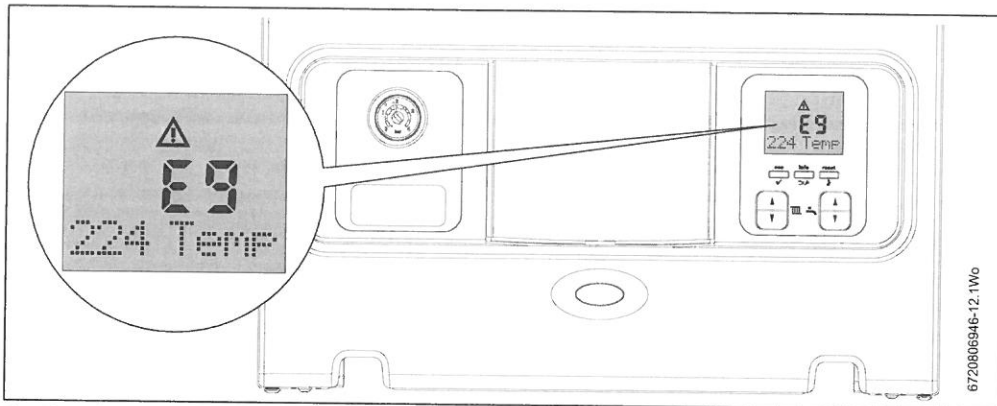



Fig. 16 Alert state example

7.2 Appliance reset

- ▶ To reset the appliance, press  briefly once.
- ▶ "Reset" and  are briefly displayed.
- ▶ If the reset was successful the appliance will return to normal operation.
- ▶ If the reset was not successful then the alert code will be displayed again, and the blue operation/fault light will continue to flash.

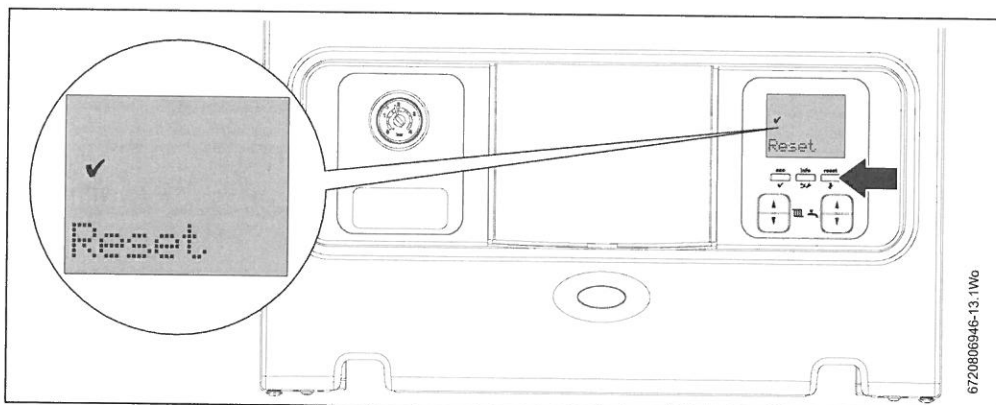

Fig. 17 Reset confirmation

Due to the internal safety systems of your Greenstar i appliance, some codes cannot be cleared by a simple reset. Please contact Worcester, Bosch Group for further assistance.

When calling Worcester, Bosch Group about a fault, it will be useful to quote the alert code and three digit number under the alert code, e.g. EA and 227. If there is a fault that cannot be reset by you, the user, then a service engineer visit will be necessary.

7.3 Extreme cold weather

The appliance has a large capacity siphonic condensate trap reducing the risk of condensate discharge freezing up in prolonged cold temperatures.

Like the CondenseSure siphon accessory, the expanded siphonic operation discharges every 15 to 20 minutes, resulting in:

- Increased velocity and flow rate.
- With only 3 to 4 siphonic actions per hour, the condensate pipework is empty for longer.
- Eliminated freezing potential.
 - For a 48 hour period at -15 °C provided the installation parameters are adhered to.

To maximise the effectiveness of this product the installer should:

- Keep the external pipework as short as possible.
- Ensure a fall of at least 2.5° over horizontal sections.
- Minimise the number of bends and connectors.
- Remove burrs after cutting pipe.
- Remove surplus solvent from the interior of the pipe.

However in certain instances where the condensate pipe work is run externally or in an unheated area, such as a garage, the condensate pipe work can be at risk of freezing, even if well insulated.

A frozen/blocked condensate pipe will cause the appliance to shut down. For guidance on frozen condensate pipework please contact Worcester, Bosch Group also available on our website are helpful videos in the Customer service section.

8 Fault or breakdown

This appliance is supported in the UK and Eire by Worcester, Bosch Group.

Specialist service engineers are available to attend a breakdown occurring on this appliance.



Invoices for attendance and repair work carried out on this appliance by any third party will not be accepted.

- No charge will be made for parts and/or labour providing:
An appliance fault is found and the appliance is within the guarantee period. Reasonable evidence of this must be supplied on request. i.e. the Benchmark Checklist.
- A call-out charge will be made where:
 - The appliance is outside the guarantee period.
 - Evidence cannot be provided that the first year service inspection has been carried out (i.e. an entry in the Benchmark Checklist).
 - Our Field Service Engineer finds no fault with the appliance.
 - The cause of breakdown is misuse or with other parts of your plumbing/heating system, or with equipment not supplied by Worcester, Bosch Group.

Technical support



No appliance fault is found on over 30% of all service calls.

In the case of a suspected fault, refer to the fault finding section of this guide.

In the event of a appliance fault or breakdown please contact Worcester, Bosch Group appointments team on 0330 123 9339. Your advisor will arrange for an engineer to call with the minimum of delay; under normal circumstances this will be from 1 - 3 working days (excluding weekends and bank holidays) for priority breakdown situations (no hot water and/or heating).

9 Tips on energy saving

Heating economically

The appliance provides a high level of comfort whilst keeping gas consumption low and so minimising the environmental impact.

The gas supply to the appliance's burner is regulated according to the demand for heat. The appliance operates with a low flame if the demand for heat reduces. The technical term for this process is modulating control.

Modulating control reduces temperature fluctuations and provides an even distribution of heat throughout the home. This means that the appliance may stay on for relatively long periods of time but will use less gas than a appliance that continually switches on and off.

Central heating systems with room thermostat/thermostatic radiator valves

With modern heating systems designed around a 20 °C heat loss across the system, the optimum setting for a condensing appliance as described on page 14 set economic temperature. The system must be balanced correctly and the radiators may need upgrading.

The temperature of each room can be set individually (except primary room with the room thermostat) using the thermostatic radiator valves.

Room thermostats

Reducing the setting of the room thermostat by 1 °C can reduce fuel consumption by up to 10%.

New control systems

Upgrade your heating control system if necessary with the latest equipment available.

Roof insulation

Around 30% of the heat loss from a property is through the roof. Replace any old insulation with new insulation, preferably of around 200mm thickness or more.

Window frames

Single glazed windows, particularly those with steel frames, can lose a great deal of heat. Consideration should be given to replacement with PVCu or wooden framed double glazed units.

Radiators

If a radiator is sited underneath a window, its performance will be affected if the curtains are allowed to drape over the radiator. Shelves fitted above or in front of the radiator should also be avoided.

It is advisable to manually adjust all thermostatic radiator valves every 2 - 3 months to prevent them sticking. Ensure radiator valves are correctly set and not damaged.

Draughts

Try to ensure that draughts around doors, windows, letter boxes and keyholes etc. are reduced by using a suitable draught excluder.



WARNING: Air vents

▶ Do not block or seal any air vents that are installed to ensure that the central heating appliance operates safely.

Curtains

Lined curtains, or heavier full length curtains can provide excellent insulation. However, always ensure that the curtains do not drape over radiators.

10 Environment/disposal

Environmental protection is a fundamental corporate strategy of the Bosch Group. The quality of our products, their economy and environmental safety are all of equal importance to us and all environmental protection legislation and regulations are strictly observed. We use the best possible technology and materials for protecting the environment taking account of economic considerations.

Packaging

We participate in the recycling programmes of the countries in which our products are sold to ensure optimum recycling. All of our packaging materials are environmentally compatible and can be recycled.



USED APPLIANCES

- ▶ All Greenstar gas appliances are 100% recyclable. The various assemblies can be easily dismantled and synthetic materials are marked accordingly. Assemblies can therefore be sorted by composition and passed on for recycling.

11 Your guarantee

This appliance has a guarantee against faulty materials or workmanship from the date of installation subject to the following terms and conditions:

- During the period of this guarantee any components of the appliance which are proven to be faulty or defective in manufacture will be exchanged or repaired free of charge by Bosch Thermotechnology Ltd.
- The householder may be asked to prove the date of installation, that the appliance was correctly commissioned and, where appropriate, the first year's service has been carried out to the satisfaction of Bosch Thermotechnology Ltd., when requested. These should be documented as a part of the Benchmark Checklist.
- The appliance has been used only for the normal domestic purposes for which it was designed.

This guarantee does not affect your statutory rights.

Guarantee registration

Your Greenstar appliance carries a guarantee against faulty material or manufacturer subject to Terms and Conditions. To read the full Terms & Conditions please visit us on-line at www.worcester-bosch.co.uk/guarantee. The Guarantee Registration form is available on this same page and can be completed and submitted electronically. Alternatively, please telephone one of our Guarantee Registration advisors on 0330 123 2552. Your statutory rights are not affected by the manufacturers guarantee.

For your own record

Please ensure that the Benchmark Checklist has been completed by your installer or service engineer.

Model	
Serial No. ¹⁾	
Type/size	
Date of installation	
Name of Installer	
Telephone number of Installer	

Table 7

- 1) See appliance identification label on appliance facia (shown in figure 1, page 6) or Benchmark Checklist in the back of the Installation, Commissioning & Servicing Instructions.

12 Glossary

Central heating systems

All radiators must be heated at an even rate. If the top of a radiator is at a lower temperature than the bottom then it should be bled by releasing air through the bleed screw at the top of the radiator.

Ask your installer to show you how this is done.

This appliance is fitted to a sealed system. Should water leaks be found or if excessive bleeding is required, then a service engineer must be contacted to inspect the installation and rectify any fault.

Only additives that are compatible with aluminium may be used in the system. Any incompatible additive used will invalidate the guarantee.

Plumbing and condensate drain

This is a condensing appliance and the flue terminal will, at times, give out a plume of water vapour. This is quite normal.

The appliance produces condensate which is discharged regularly by a syphon within the appliance via a plastic pipe to a drain. This pipe must not be blocked or altered in any way.

Room thermostat/programmer

A room thermostat / programmer must be fitted to control the central heating. This controls the times and temperatures of the central heating, preventing the appliance from firing unnecessarily. Refer to the instructions supplied with the thermostat and programmer for further information.

Thermostatic radiator valves

Thermostatic radiator valves must be fitted in sleeping accommodation. It is recommended that this type of valve is fitted to all but one of the radiators. The remaining radiator, where the room thermostat is located, must be uncontrolled and left open.

Pump over run function

After the appliance has finished a demand for central heating or hot water, the pump may continue to run for a short while to dissipate the heat from within the appliance.

Pump anti-seizure

If there has been no heating demand for 24 hours, the appliance will run the system pump for a few seconds to reduce the possibility of pump seizure during long periods of inactivity.

Notes

WORCESTER, BOSCH GROUP:

TECHNICAL SUPPORT:	0330 123 3366
APPOINTMENTS:	0330 123 9339
SPARES:	0330 123 9779
LITERATURE:	0330 123 9119
TRAINING:	0330 123 0166
SALES:	0330 123 9669

Worcester, Bosch Group
Cotswold Way, Warndon, Worcester WR4 9SW.
Tel. 0330 123 9559
Worcester, Bosch Group is a brand name of
Bosch Thermotechnology Ltd.

worcester-bosch.co.uk

6 720 806 946 (2015/03)

